

FIELD INSTRUCTIONS

2014-08

FORM: F269 486A

Use above FORM number when ordering extra manuals.

For FieldPro™ SmartFeeder Calibration Procedure Using A Calibration Card

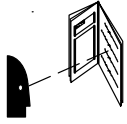

Have only trained and qualified persons install, operate, or service this unit. Call your distributor or the equipment manufacturer if you do not understand the directions. For WELDING SAFETY and EMF information, read Owner's Manual.

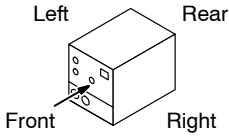

All directions are given as facing front panel.
Keep hardware for reuse.

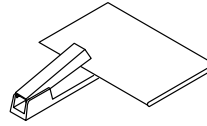



Staple these instructions inside Owner's Manual.

1. Safety Symbol Definitions

	<p>DANGER! – Indicates a hazardous situation which, if not avoided, will result in death or serious injury. The possible hazards are shown in the adjoining symbols or explained in the text.</p> <p style="text-align: right;"><small>Fsafe1 2013-10</small></p>		<p>Beware of electric shock from welding electrode or wiring. Touching the electrode while in contact with the work or ground can cause electric shock. Always wear dry gloves. Keep all panels and covers closed.</p> <p style="text-align: right;"><small>Fsafe5 2013-10</small></p>
	<p>Indicates a hazardous situation which, if not avoided, could result in death or serious injury. The possible hazards are shown in the adjoining symbols or explained in the text.</p> <p style="text-align: right;"><small>Fsafe2 2013-10</small></p>		<p>Wear safety glasses with side shields.</p> <p style="text-align: right;"><small>Fsafe8 2013-10</small></p>
<p>NOTICE</p>	<p>Indicates statements not related to personal injury.</p> <p>Indicates special instructions.</p> <p style="text-align: right;"><small>Fsafe3 2013-10</small></p>		
<p>CALIFORNIA PROPOSITION 65 WARNINGS</p>			
<p>Welding or cutting equipment produces fumes or gases which contain chemicals known to the State of California to cause birth defects and, in some cases, cancer. (California Health & Safety Code Section 25249.5 et seq.)</p> <p>This product contains chemicals, including lead, known to the state of California to cause cancer, birth defects, or other reproductive harm. Wash hands after use.</p> <p style="text-align: right;"><small>Fsafe4 2013-10</small></p>			

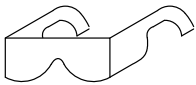
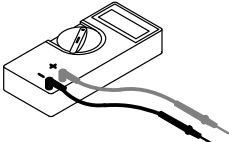
2. Tools Needed

DC ammeter (e.g. Fluke 337)

Meters must be calibrated.

3. Location Of Memory Card Slot

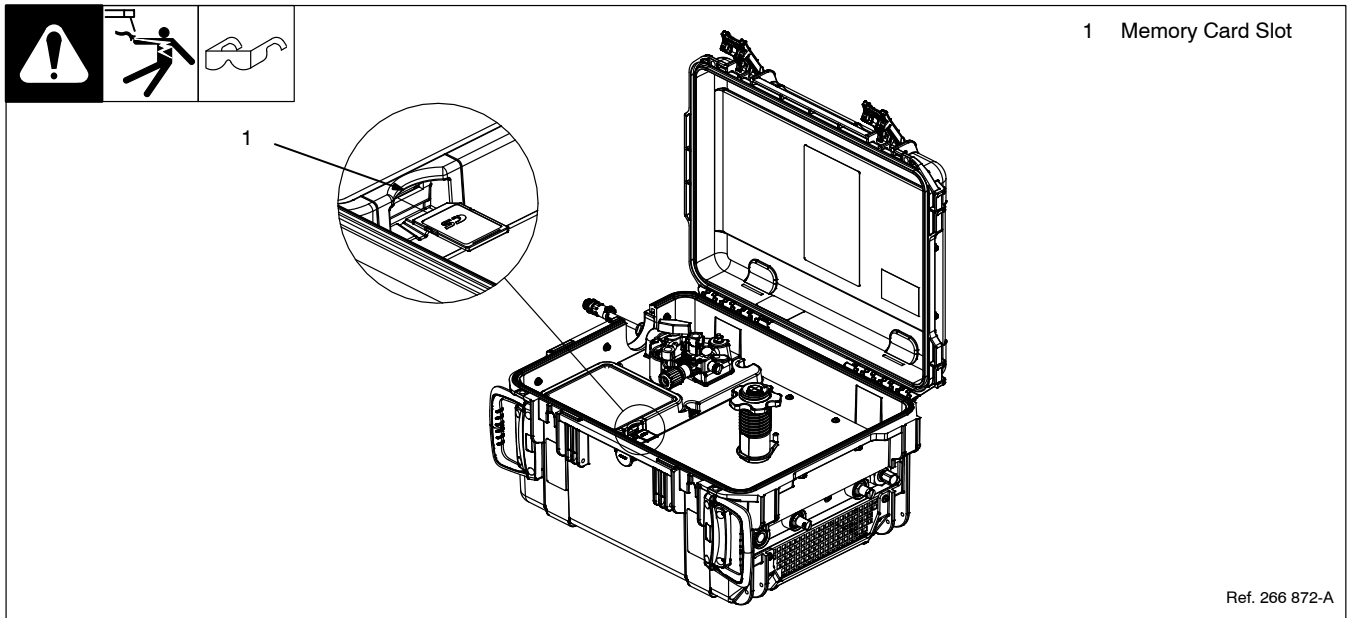

4. Power Source Calibration Procedure

1. Connect FieldPro SmartFeeder to welding power source.
 2. Connect load bank to weld output terminals.
 3. Set Load bank to 300 amps.
 4. Clamp DC ammeter around output cable.
 5. Attach DC voltmeter across work lead and output terminal at wire drive assembly.
 6. Turn on power to the welding system.
 7. Insert Calibration SD Card into memory card slot. Feeder display will read 'CAL'.
 8. To turn on output, press 'IN USE' button. Unit should output approximately 300 amps (± 25 amps) at 32 volts. Unit displays will read output amps and voltage.
- ⚠ Output voltage must be close to 32 volts for wire feeder to calibrate properly. If voltage is not close to 32 volts, adjustment the load bank.*
9. Use '+' and '-' buttons on the wire feeder to adjust values in each display until they match the readings on the external meters.
 10. When calibration is complete, turn off welding output by pressing the 'IN USE' button. Display will read 'CAL'.
 11. Remove Calibration SD Card from memory slot.